

Climate Control

INTRODUCTION

This vehicle is fitted with one of the following climate control systems:

- Manually controlled system with air conditioning. See page 150.
- Automatic climate control system with an LCD (liquid crystal display) screen. See page 153.
- Automatic climate control system with touch-screen (shared with the navigation and audio systems). Where this control unit is fitted, refer to the touch-screen display handbook for detailed operating instructions.

Each system has a unique control panel located in the centre console above the radio and audio controls.

General information applicable to all three systems is given below.

RECOMMENDED OPERATION

Use of air conditioning

The manual and automatic climate control systems are fitted with air conditioning to provide cooling and dehumidified air.

The dry airflow is also effective in preventing misting of the windows. It is recommended that air conditioning is used in all climatic conditions throughout the year, even when warm airflow is required.

Close all windows and the sunroof when the air conditioning is on to ensure satisfactory operation.

Note: *Selecting air recirculation will improve the performance of the air conditioning in very hot conditions.*

Use of air recirculation

The air conditioner/heater system is supplied with fresh air via an intake flap.

The flap may be closed to allow the air inside the vehicle to be recirculated. This helps to prevent unpleasant odours from being drawn into the vehicle.

On all systems, air recirculation may be manually selected either for an automatically timed period or to remain on continuously (latched recirculation).

When latched recirculation is selected, the air conditioning will switch on automatically to reduce condensation.

Note: *When air recirculation is selected, the sound of the airflow will change. This is normal.*

Automatic climate control systems

With automatic climate control systems, the air conditioning, recirculation and other functions are fully controlled in AUTO mode to provide optimum comfort under most driving conditions.

It is recommended that AUTO is selected as the normal operating mode on these systems.



WARNING:

To prevent humidity build up inside the vehicle and possible screen misting, avoid driving with the air conditioning system off or in manual air recirculation for prolonged periods.

Climate Control

GENERAL POINTS

To ensure the satisfactory operation of the climate control system, note the following points:

- Ensure that the external grille at the base of the windscreen, which provides fresh air for the climate control system, is kept clear of leaves, snow or obstructions.
- Air ducts under the front seats supply the rear passenger footwells (refer to illustration on page 149). Objects or material placed under the seats may block or obstruct the open ducts.
- The external air intake to the air conditioner/heater system is fitted with a filter. Ensure that the filter is changed at the specified service intervals to maintain efficient operation.
- If the air conditioning system is not used frequently, it should be run briefly at least once each week, with a cold setting, to prevent the seals from drying out with subsequent refrigerant leaks.
- Moisture removed from the air by the air conditioning unit is discharged onto the road underneath the vehicle. After stopping, puddles of water may form underneath the vehicle: this is normal.

AUXILIARY HEATER (DIESEL ONLY)

The auxiliary heater aids in warming the engine and interior compartment. It is integrated into the cooling system and is automatically switched on or off depending on the coolant temperature and outside air temperature, while the engine is running.

There are two types of auxiliary heater, either fuel-fired or electric. Vehicles are only fitted with fuel fired heaters in certain cold climate countries.

It is possible that when the fuel-fired heater is activated, exhaust gas may appear from under the side of the vehicle for a short time. This is normal.

PANEL ILLUMINATION

With the exterior lighting switched on, the graphics on the panel controls are illuminated by low level backlighting.

The illumination level is adjusted by the common instrument panel dimmer control.

Climate Control

AIR DISTRIBUTION

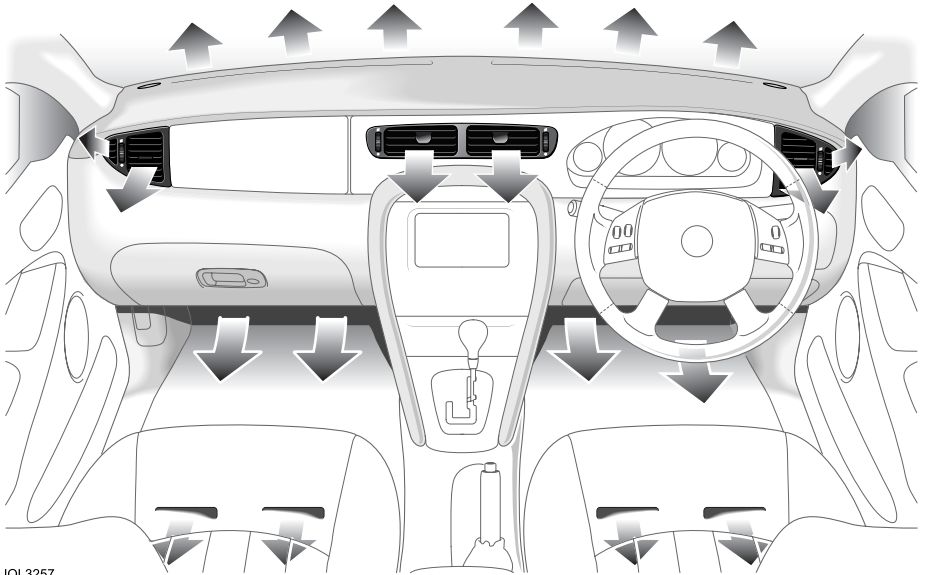

JOL3257

The illustration shows the location of the air vents within the vehicle.

On vehicles fitted with automatic climate control, the appropriate air distribution is selected automatically when operating in AUTO mode.

On all climate control systems, the distribution of air between the screen, fascia and floor level can be manually selected using the panel controls.

The airflow from the fascia face level vents is regulated using thumbwheel controls and adjustable direction vanes.

Manual Climate Control

MANUAL CONTROL PANEL

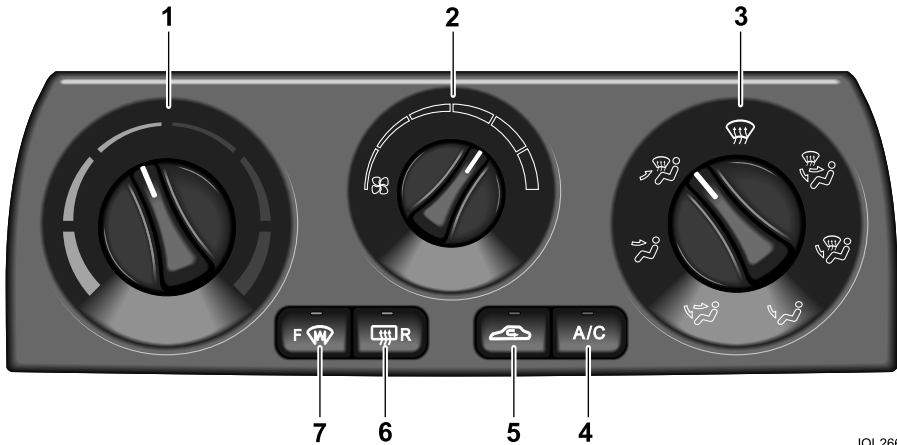

JOL2660

1. Temperature control.
2. Blower speed.
3. Air distribution.
4. Air conditioning.
5. Recirculated/fresh air.
6. Heated rear screen.
7. Heated front screen (where fitted).

The manual climate control panel is shown here. The temperature, airflow distribution and volume of air from the interior vents are set using the rotary controls.

Push on/push off buttons control the air conditioning, screen heating and fresh or recirculated air. An amber or red LED on each button is illuminated when the selected function is operating.

The following pages describe the controls in greater detail.

Note: It is advisable to allow the system to stabilise before making large changes to the temperature setting, particularly at the start of a journey (see **Temperature Control** below).

TEMPERATURE CONTROL

Rotating the control knob (1) clockwise from the blue region to the red region increases the temperature of the airflow. The knob may be set to any position for optimum comfort.

BLOWER SPEED

The blower is switched off by turning the rotary control (2) anti-clockwise, until it points to the narrowest end of the scale to the left. The blower can be switched through 6 positions, providing stepped increases in blower speed.

With the blower switched off, the airflow results from the forward motion of the vehicle (ram air effect).

Manual Climate Control

Air conditioning cannot be switched on when the blower is switched off. If the blower is switched off, the air conditioning will switch off and the LED will extinguish.



WARNING:

Switching the blower off may increase the possibility of screen misting due to reduced airflow.

AIR DISTRIBUTION

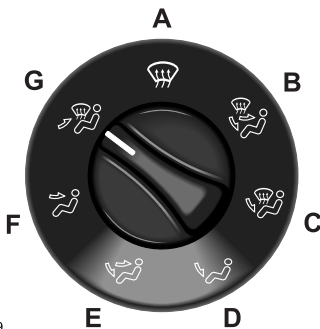

JOL2949

The rotary control has seven main air distribution positions but the air distribution changes continuously between positions as the knob is rotated. The control knob may therefore be set at any point for optimum comfort.



WARNING:

Directing cold air onto the screen in warm humid conditions can produce external condensation.

The air distribution settings are, from the top clockwise:



Airflow directed to windscreen only (A); select to remove frost or heavy misting.



Airflow distributed to the windscreen, face and foot levels (B).



Airflow distributed to the windscreen and feet (C); select to prevent or remove light misting and when heating the interior.



Airflow directed to foot level (D); optimum position for heating interior (if warm airflow selected).



Airflow distributed to the face and feet (E).



Airflow directed at face level only (F); optimum position for cooling interior (if cool airflow selected).



Airflow distributed to the windscreen and face (G).

AIR RECIRCULATION



Press the button briefly to select timed air recirculation.

To select latched air recirculation, press and hold the button until the LED flashes four times then remains illuminated.

Manual Climate Control

To deselect air recirculation and open the fresh air intake, press the button again (LED off).

Note that air recirculation cannot be selected in position **(A)** (defrost) of the air distribution control.

Select air recirculation:

- To stop outside odours from entering the vehicle.
- To improve the performance of the air conditioning in regions of high ambient temperatures or when the interior is extremely hot. Note that air recirculation is cancelled when the ignition is switched off, and must therefore be re-selected after each engine start if required.



WARNING:

Prolonged operation with recirculation selected in cold, damp conditions could result in screen misting.

AIR CONDITIONING



The air conditioning only operates with the blower switched on and will switch off if blower is switched off.

If the air distribution control is set to any of the screen defrost/demist positions **(A, B, C, G)**, the air conditioner switches on automatically.

Air conditioning cannot be deselected in defrost position **(A)**.

HEATED FRONT AND REAR SCREENS



Pressing the push button selects the front screen heater, provided the engine is running.

The front heater switches off automatically after 3 minutes or can be switched off by pressing the button again.



Pressing the button selects the rear screen heater and both door mirror heaters, provided the engine is running.

The rear screen and door mirror heaters switch off automatically after 6 minutes or can be switched off by pressing the button again.

WINDSCREEN DEFROST/DEMIST

Frost and heavy misting



To remove frost or heavy misting from the windscreen:

1. Start the engine.
2. Turn the air distribution mode control to the defrost/demist position **(A)**.
3. Set the temperature control to maximum to remove frost.
4. Select a blower speed, preferably maximum. The air conditioning will switch on automatically if the engine is running.
5. If fitted, select the front windscreen heater.
6. If required, select the rear screen heater; this control also switches on both door mirror heaters.

Light misting



To prevent or remove light windscreen misting, select air distribution position **(C)**.

Note: Air conditioning will reduce misting, even when warm airflow is selected: the system will still dehumidify the air.

Automatic Climate Control

AUTOMATIC CONTROL PANEL



JOL3275

1. Blower speed and system on/off.
2. Recirculation/fresh air.
3. Display panel with typical symbols.
4. Celsius/Fahrenheit selector.
5. Automatic operation.
6. Air conditioner on/off.
7. Air distribution.
8. Increase temperature.
9. Decrease temperature.
10. Heated rear screen/door mirrors.
11. Heated front screen (where fitted).
12. Defrost.

The automatic climate control system maintains the interior of the vehicle at the temperature selected by the occupant. The heat input, air conditioning, blower speed, air intake and distribution are adjusted automatically to maintain the desired temperature.

Note: It is advisable to allow the system to stabilise before making large changes to the temperature setting, particularly at the start of a journey (see **Temperature Selection** on page 154).

Automatic control (AUTO) may be overridden at any time. Defrost/demist operation is available and also manual selection of blower speed, air distribution, recirculation, air conditioning and windscreen heating.

The climate control functions are selected by push buttons and a rotary control. When a button is pressed, selection is confirmed by a beep and illumination of the button LED.

Most functions also have associated graphic symbols displayed on the LCD (liquid crystal display) screen.

TO SWITCH THE SYSTEM ON

The climate control system operates in position II (run) of the ignition switch.

Automatic Climate Control

With the ignition key turned to the run position, the system will switch on in the operating mode last set.

For normal usage select AUTO mode.

AUTO MODE

 Automatic operation provides a controlled environment over a temperature range of 17°C (61°F) to 31°C (89°F) and should be regarded as the normal operating mode.



To select automatic climate control press the AUTO button; the word AUTO appears on the LCD screen to confirm selection.

Select the required temperature.

Front and rear screen heating and timed air recirculation may be selected in AUTO mode. Selecting any other control will cancel AUTO operation.

Automatic operation cannot be deselected using the AUTO button. To exit AUTO mode, select another mode or press the blower control knob to switch the system off.

TEMPERATURE SELECTION

  Set the required interior temperature with the red and blue arrowed buttons. Press the red button to increase temperature and the blue button to decrease temperature.

The selected temperature will appear on the lower part of the LCD screen.

Pressing the buttons to select the maximum or minimum temperature settings causes the display to change to HI or LO respectively and cancel AUTO mode.

To quickly jump from HI or LO to a convenient midrange temperature of 23°C (73°F), press and hold AUTO for a few seconds.

When AUTO is selected, the system constantly monitors the conditions inside and outside the vehicle. For your maximum comfort, it is advisable to allow the system to stabilise before making large changes to the temperature setting, particularly at the start of a journey.

EXTERNAL TEMPERATURE

The external (EXT) temperature is displayed at the top of the screen.

CELSIUS/FAHRENHEIT SELECTION

 Press the button to change the scale between degrees Celsius (°C) and degrees Fahrenheit (°F) for the displayed internal and external (EXT) temperatures.

AIR RECIRCULATION

Timed air recirculation

 Press the button briefly to select timed air recirculation.

The fresh air intake is opened and the button LED extinguished at the end of the time out period.

Latched air recirculation

 Press and hold the button for a few seconds to select latched air recirculation. Selection is indicated by the screen symbol and two beeps.

Selecting latched air recirculation cancels AUTO operation.

Automatic Climate Control

To deselect latched air recirculation, press the recirculation button again, or select AUTO.



WARNING:

Prolonged operation with recirculation selected in cold, damp conditions could result in screen misting.

WINDSCREEN DEFROST/DEMIST

Frost and heavy misting



To remove frost or heavy misting from the windscreen, press the DEF button.

- The blower switches on automatically at 70% of maximum speed but the speed can be increased or reduced manually if required.
- Air conditioning switches on automatically (to dehumidify the air) and cannot be deselected.
- Recirculation is cancelled and cannot be selected.
- The front screen heater and the rear screen heater/door mirror heaters switch on automatically, provided the engine is running.

To deselect defrost mode, press AUTO (recommended operating mode, to maintain a mist-free screen).

Light misting



To prevent or remove light windscreen misting, select manual air distribution to windscreen and feet. See page 156.

Note: Air conditioning will reduce misting, even when warm airflow is selected: the system will still dehumidify the air.

HEATED SCREENS AND DOOR MIRRORS



The front (F) and rear (R) screen heaters may be switched on and off in any mode, including system off, but will only operate when the engine is running. The door mirror heaters are also controlled by the rear screen heater button.

The front screen heater switches off automatically after 3 minutes. The rear screen and door mirror heaters switch off automatically after 6 minutes.

The windscreen heaters may be manually deselected during the time out period using the push buttons.

In cold ambient conditions, at the start of a journey, the front and rear screen heaters will switch on automatically for the time out period.

AIR CONDITIONING



Press to switch the air conditioning on or off.

The air conditioning system is controlled automatically in AUTO mode to maintain the desired temperature and humidity (even if higher temperature settings are selected). Deselecting A/C cancels AUTO mode.

The air conditioning system is also switched on automatically in defrost mode (DEF) in order to dehumidify the air: it cannot be deselected in this mode.

Automatic Climate Control

BLOWER SPEED



Set the blower speed as required with the rotary control knob. Blower speed is shown as a series of bars on the LCD screen.

When operating in AUTO mode, blower speed is controlled automatically (but not displayed) and any adjustment of the knob will cancel AUTO mode.

Note: In AUTO mode, the blower only operates at low speed, if heating is required, until the engine is warm.

MANUAL AIR DISTRIBUTION

Air distribution is automatically controlled in AUTO and defrost modes.

Press one of the four air distribution buttons to cancel the current mode and select manual operation. The symbol for the selected air distribution will appear on the LCD screen.

The air distribution options are:



Airflow directed at face level only; optimum position for cooling interior (if cool airflow selected).



Airflow distributed to the face and feet.



Airflow directed to foot level; optimum position for heating interior (if warm airflow selected).



Airflow distributed to the windscreen and feet; select to prevent or remove light misting and when heating the interior.

TO SWITCH THE SYSTEM OFF

Press in the blower rotary control knob to switch the climate control system off.

If the blower control knob is pressed again, the system will switch on in the previous mode set.

RAM AIR

With the climate control system switched off, air recirculation is automatically selected (intake flap closed). To select fresh air with the system off, press one of the air distribution buttons.

With the blower switched off, the fresh airflow results from the forward motion of the vehicle (ram air effect).



WARNING:

Selecting ram air (or switching the system off when the windows are closed) may increase the possibility of screen misting due to reduced airflow.